

# Planungsskizze fuer Hospicar® + swingo-visit

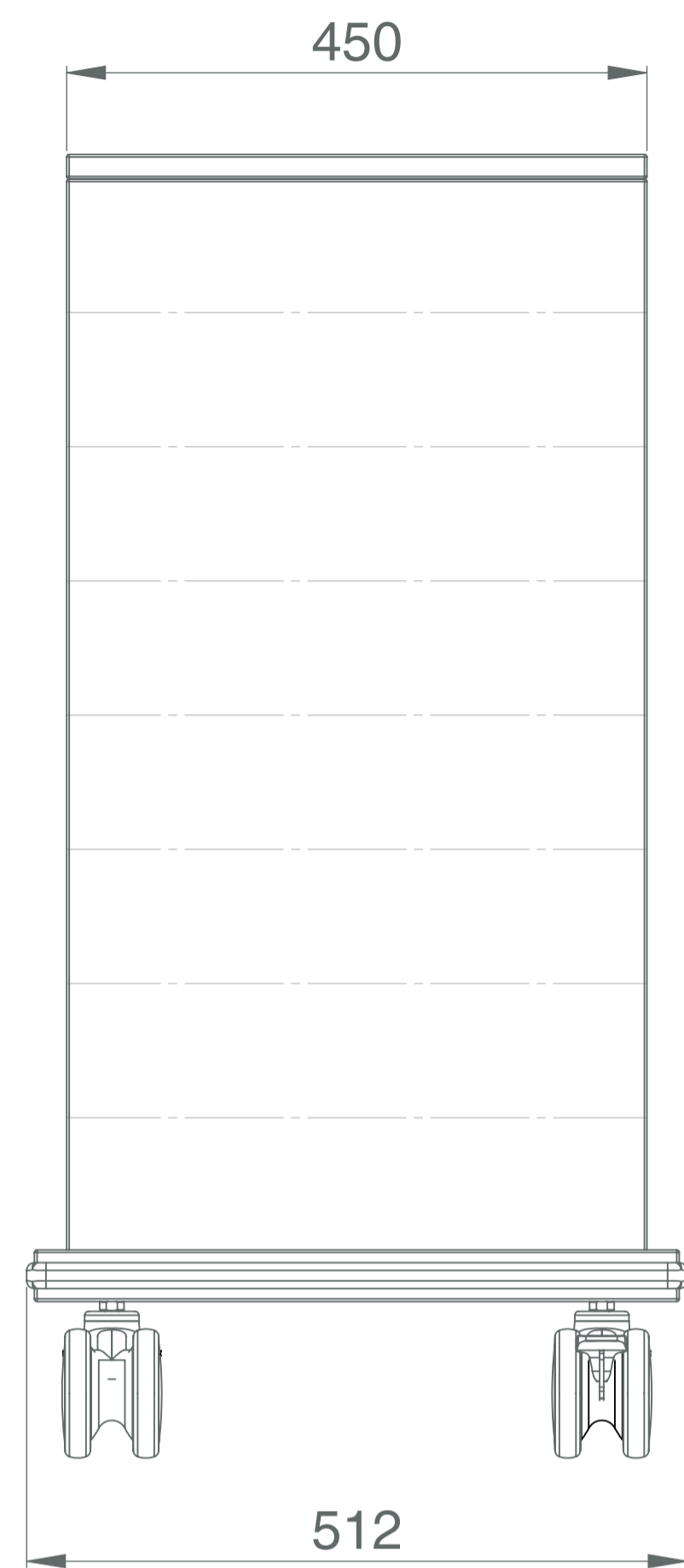

Schublade  
100 mm hoch  
(1 Rasterhoehe)

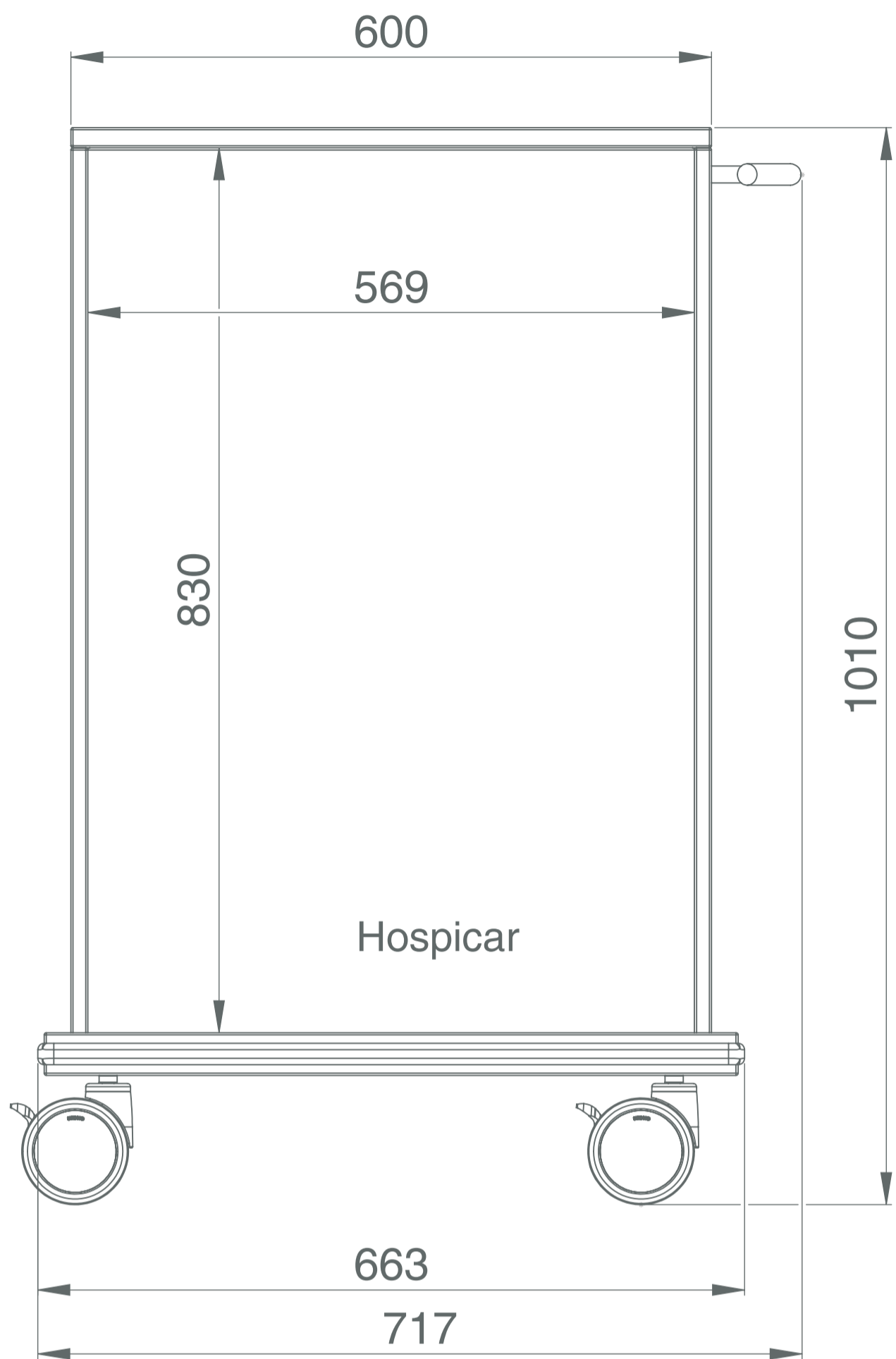
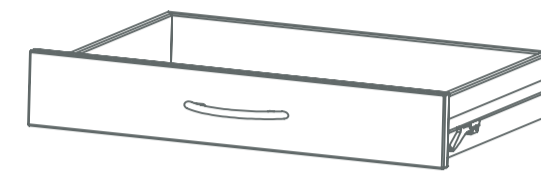

<input type="checkbox"/>	<input type="checkbox"/>
<b>schmal</b>	<b>breit</b>
330	565
Breite in mm	

200 mm hoch  
(2 Rasterhoehen)

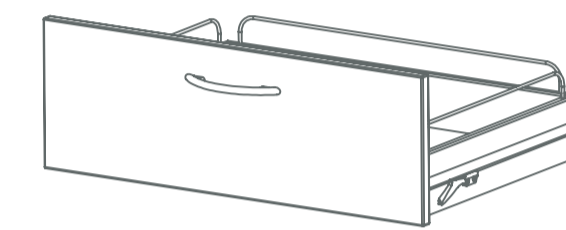

<input type="checkbox"/>	<input type="checkbox"/>
<b>schmal</b>	<b>breit</b>
330	565
Breite in mm	

Karteiauszug  
(3 Rasterhoehen)

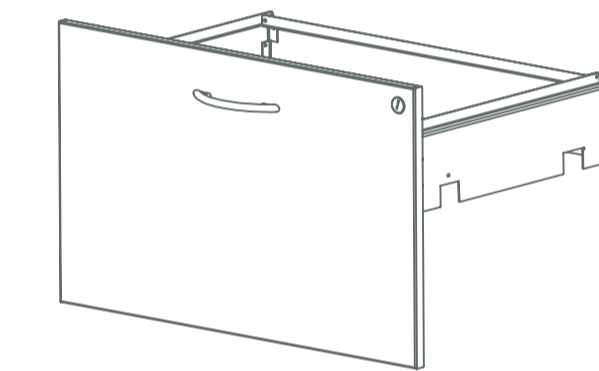

<input type="checkbox"/>
<b>breit</b>
565
Breite in mm

Fachboden

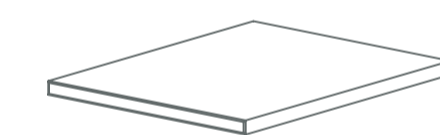

<input type="checkbox"/>	<input type="checkbox"/>
<b>schmal</b>	<b>breit</b>
330	565
Breite in mm	

Senkrechte Trennwand

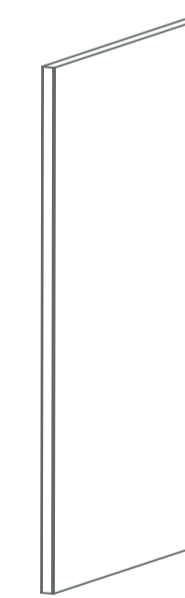

<input type="checkbox"/>	fuer Roentgen- taschenfaecher
<input type="checkbox"/>	Trennwand fuer schmale Schubladen + Fachboeden

Galerieaufsatz

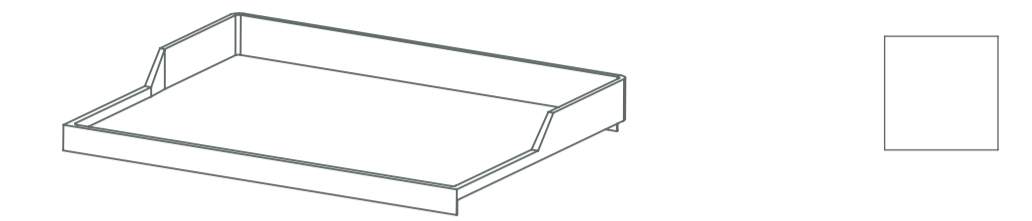

(Nur bei 600 mm breiten Wagen)

Schubladeneinsatz

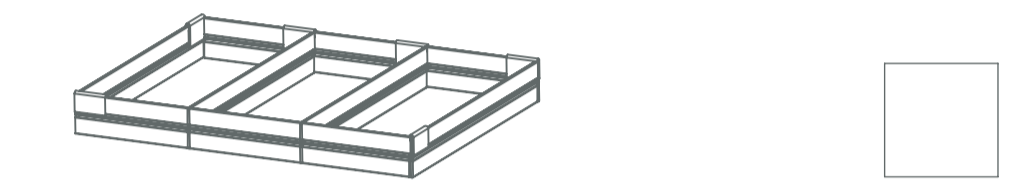

(Nur bei breiten Schubladen)

Farben: (nach EGGER Decor)

<b>Korpus:</b>	<input type="checkbox"/>	<input type="checkbox"/>
	weiss (W980St2)	farbig

<b>Frontblende:</b>	<input type="checkbox"/>	<input type="checkbox"/>
	weiss (W980St2)	farbig

Hospicar + swingo visit sind in individuellen Abmessungen moeglich.

Bitte kontaktieren Sie uns

Bemerkungen:

---



---



---



---



---



---



---

